



The ModBox-CBand-12.5Gb/s-DPSK is an optical modulation unit that generates high performance DPSK and NRZ optical data streams up to 12.5 Gb/s, and analog modulation up to 10 GHz. The equipment incorporates a modulation stage based on a high data rate LiNbO₃ Mach-Zehnder modulator, coupled with a high performance RF driver and an automatic bias control circuitry. It can also receive an internal tunable laser source.

The ModBox-CBand-12.5Gb/s-DPSK provides R&D and production engineers with state of the art performance and the peace of mind of a turn-key instrument. It can be used as a reference transmitter in optical telecommunications laboratories, or in production test beds.

FEATURES

- Full C-Band Reference Transmitter
- Up to 12.5 Gb/s DPSK, NRZ
- Analog modulation up to 10 GHz
- Reliable & reproducible measurements
- High eye diagram stability

APPLICATIONS

- Transmission system test
- Components characterization
- Production test
- R&D laboratories

OPTIONS

- Low bit rate down to 10 Mb/s
- DPSK based on Phase Modulator

Performance Highlights

Parameter	Min	Typ	Max
Operating wavelength	-	C-Band	-
Modulation format	DPSK and NRZ / Analog		
Modulation bandwidth	12.5 Gb/s / 10 GHz		

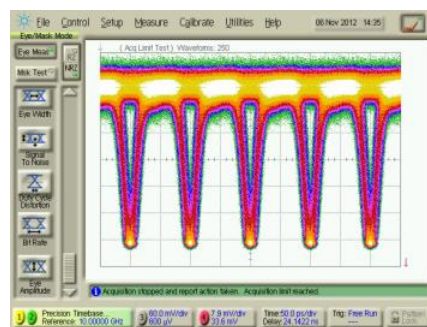

10 Gb/s Optical DPSK Eye Diagram

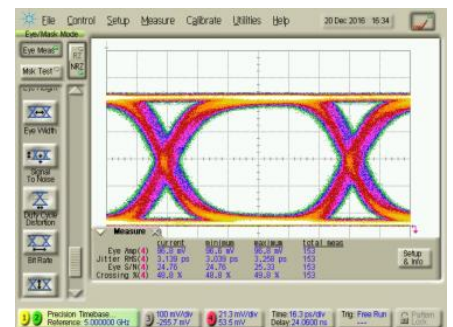

10 Gb/s Electrical Demodulated Eye Diagram

Functional Block Diagram

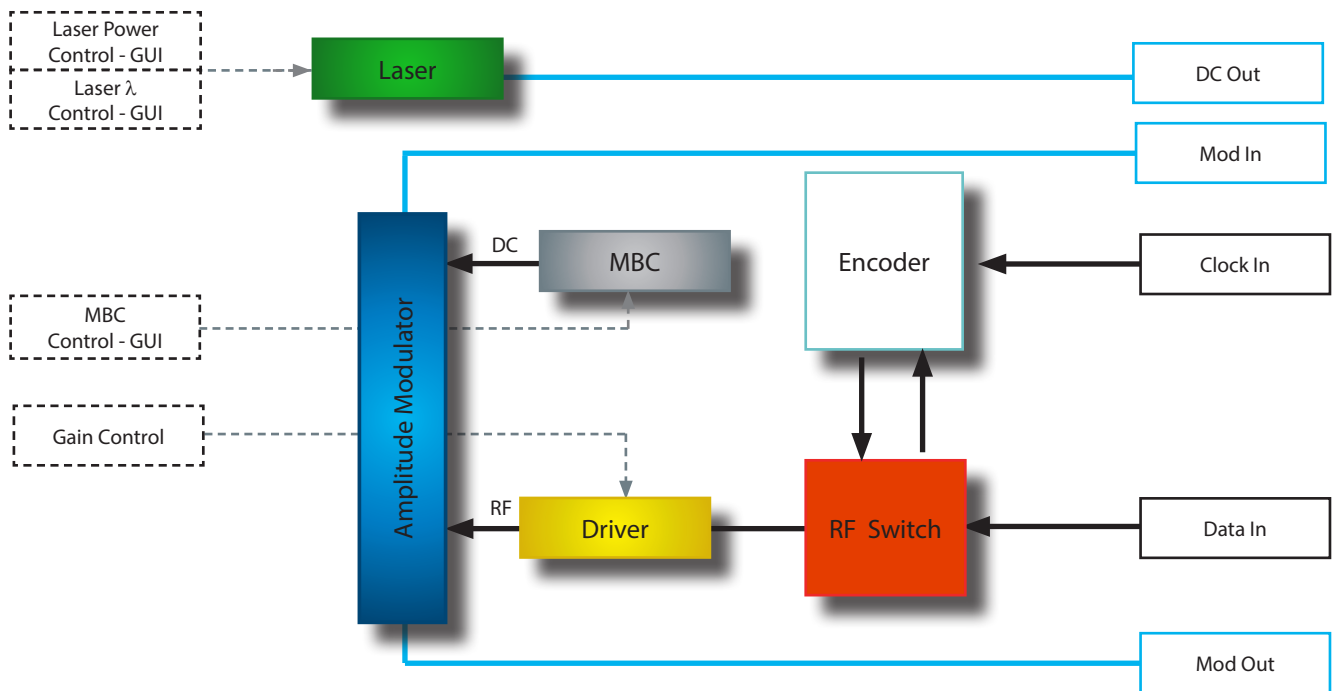

The ModBox-CBand-12.5Gb/s-DPSK integrates:

- a laser source, tunable type, with its high precision driver that allows control of the output power and its wavelength,
- a set of modulation composed of a wide bandwidth, chirp-free, LiNbO₃ Mach-Zehnder modulator which is associated to its matching wide bandwidth RF driver (with gain level adjustment for eye diagram optimization) and bias control circuit (MBC, Modulator Bias Controller) to lock the Mach-Zehnder modulator at the desired operating point (Min for DPSK, Quad for NRZ and Analog, and Max for DC modes) and ensure a highly stable output optical signal,
- an electrical encoder for DPSK modulation scheme selected through a RF switch path.

Input Electrical Specifications User supplied, not a ModBox specification

ID	Parameter	Symbol	Condition	Min	Typ	Max	Unit
0.1	Data-rate	-	DPSK, NRZ	100 M	-	12.5 G	b/s
0.3	Frequency range	-	Analog	100 M	-	10 G	Hz
0.5	Data input voltage	Data _{IN}	NRZ ⁽¹⁾	0.400	0.450	0.500	Vpp
			Analog mode ⁽¹⁾	-	0.125	0.150	Vpp
0.6	Jitter	J _{RMS}	-	-	1	1.2	ps
0.7	Rise / fall time	t _r / t _f	20% - 80%	-	-	40	ps
0.8	Clock input voltage	Clock _{IN}	Analog signal	-	0.500	-	Vpp

(1): AC coupled - 50 Ω - Single ended

Input Optical Specifications User supplied, not a ModBox specification. External laser specifications.

ID	Parameter	Symbol	Condition	Min	Typ	Max	Unit
1.1	Operation	λ	CW	1530	-	1675	nm
1.2	Polarisation	Pol	PM fiber - FC/APC	Linear and controlled			-
1.3	Power	P _{IN}	-	10	-	20	dBm
1.4	Side mode sup ratio	SMSR	Intrinsic laser value	30	-	-	dB
1.5	Spectrum linewidth	Δλ	Intrinsic laser value	-	1	20	MHz

Absolute Maximum Ratings

Stresses in excess of the absolute maximum ratings can cause permanent damage to the device. These are absolute stress ratings only. Functional operation of the device is not implied at these or any other conditions in excess of those given in the operational sections of the data sheet. Exposure to absolute maximum ratings for extended periods can adversely affect device reliability.

	Parameter	Symbol	Min	Max	Unit
0.9	Data input voltage	Data _{IN}	-	1	Vpp
0.10	Clock input voltage	Clock _{IN}	-	1	Vpp
1.6	Optical input power	Mod _{IN}	-	20	dBm

Modulated Output Optical Specifications Specifications below are given with embedded tunable laser and supplied PRBS.

	Parameter	Symbol	Condition	Min	Typ	Max	Unit
2.1	Embedded laser type	-	Intrinsic laser value	Tunable			-
2.2	Wavelength	λ	Intrinsic laser value	1527.60	-	1565.50	nm
2.3	Wavelength accuracy	$\Delta\lambda_{acc}$	Intrinsic laser value	-1.5	-	1.5	GHz
2.4	Spectrum linewidth	$\Delta\lambda$	Intrinsic laser value	-	10	100	kHz
2.5	Side Mode Supression	SMSR	Intrinsic laser value	40	-	-	dB
2.6	Optical Signal to Noise	OSNR	Intrinsic laser value	40	-	-	dB
2.7	Optical output power	Mod Out / Amp Mod Out	Modulation On - @1550 nm	10	-	-	dBm
2.8			Modulation On / Full C-band	7	-	-	dBm
2.9			Modulation Off - @1550 nm	13	-	-	dBm
2.10			Modulation Off / Full C-band	10	-	-	dBm
2.11	Data-rate	-	DPSK, NRZ	100 M	-	12.5 G	b/s
2.12	Frequency range	-	Analog	10 M	-	10 G	Hz
2.13	Dynamic Signal to Noise	SNR	NRZ	20	-	-	dB
2.14	Extinction ratio	ER	NRZ	12	15	-	dB
2.15	High extinction ratio	HER	NRZ - Option Opt-HER	15	18	-	dB
2.16	RMS jitter	J_{RMS}	NRZ	-	-	2	ps
2.17	Rise / fall time	t_r / t_f	20 % - 80 %	-	40	50	ps
2.18	Optical return loss	ORL	Modulated signal	-40	-45	-	dB
2.19	Polarisation extinction	PER	Modulated signal	15	20	-	dB

Modulated DPSK Eye Diagrams from ModBox Transmitter

The following equipment was used in obtaining these results :

- Agilent Infinium DCA 86100B
- Anritsu synthesizer MG3694C
- Anritsu Signal Analyzer MP1800A
- Photodiode finisar XPDV2320R

5 Gb/s data rate

Input electrical signal

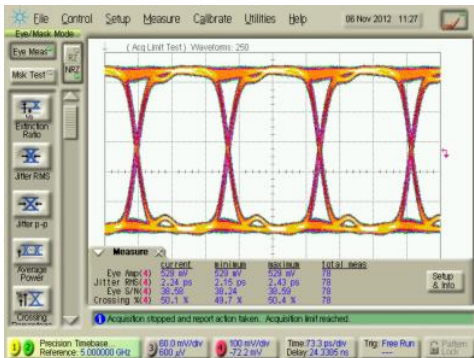

Eye Amp = 529 mV Jitter p-p = 11 ps
Jitter RMS = 2.2 ps Rise time (10/90) = 42 ps
Eye S/N = 38 Fall time (10/90) = 44 ps

DPSK Output optical signal

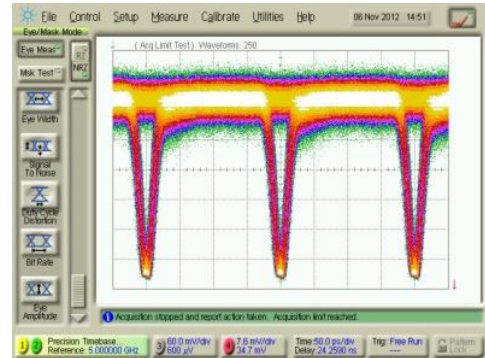

10 Gb/s data rate

Input electrical signal

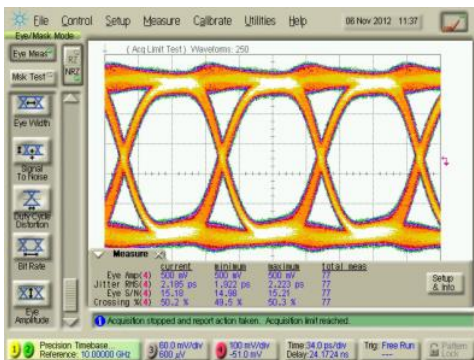

Eye Amp = 500 mV Jitter p-p = 12 ps
Jitter RMS = 2.18 ps Rise time (10/90) = 43 ps
Eye S/N = 15 Fall time (10/90) = 38ps

DPSK Output optical signal

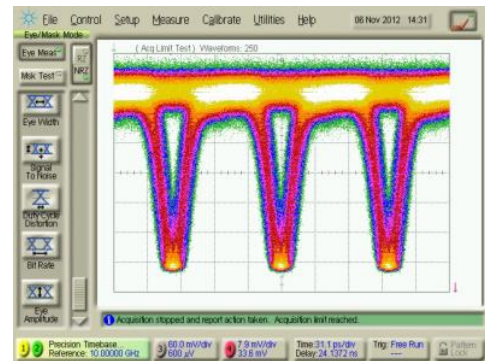

12 Gb/s data rate

Input electrical signal

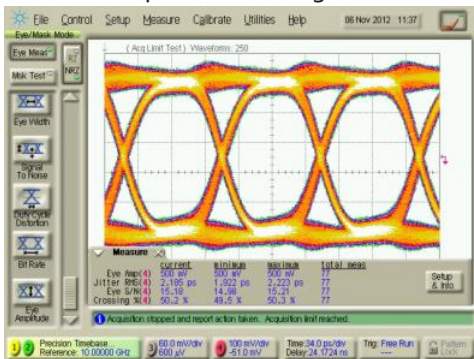

Eye Amp = 500 mV Jitter p-p = 12 ps
Jitter RMS = 2.18 ps Rise time (10/90) = 43 ps
Eye S/N = 15 Fall time (10/90) = 38ps

DPSK Output optical signal

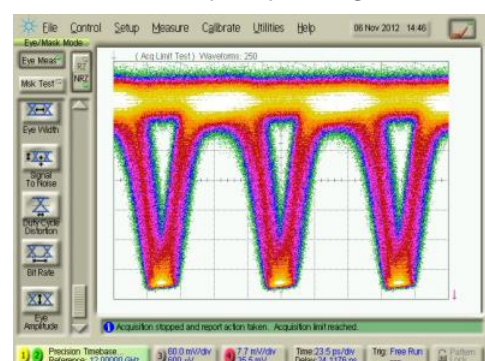

Modulated NRZ Eye Diagrams from ModBox Transmitter

The following equipment was used in obtaining these results: Agilent Infinium DCA 86100D, Anritsu Signal Analyzer MP1800A and Anritsu synthesizer, Photodiode finisar XPDV2320R

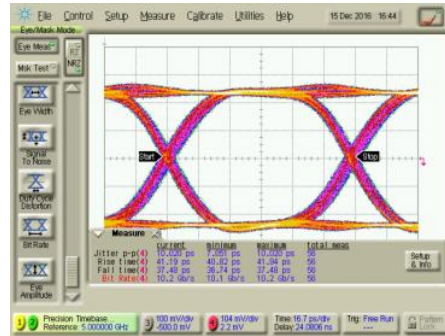
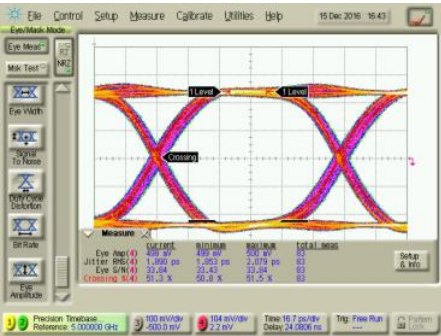

Electrical input PRBS31 10 Gb/s

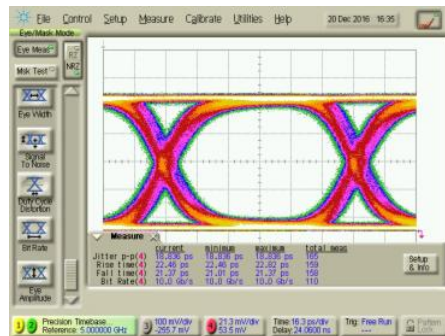
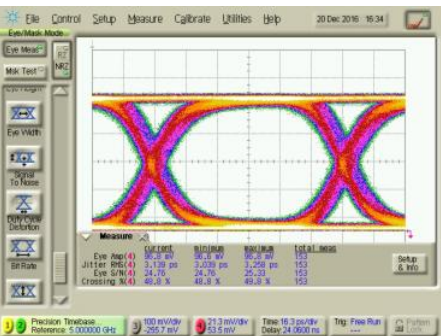

Optical output PRBS31 10 Gb/s

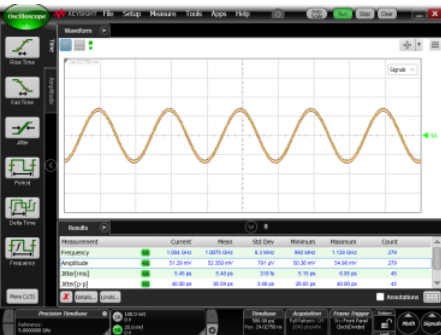

Electrical input 1 GHz

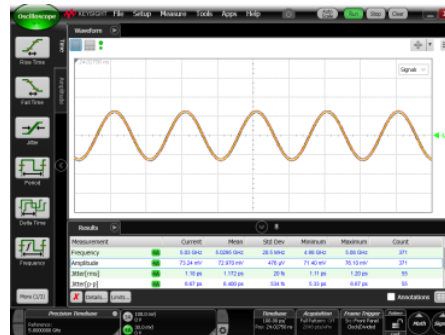

Electrical input 5 GHz

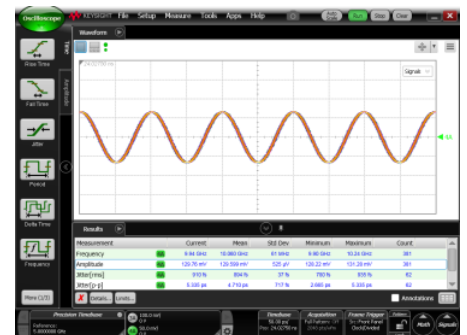

Electrical input 10 GHz

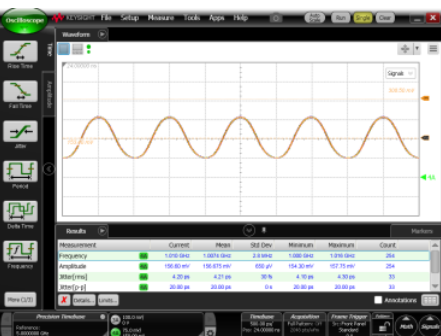

Optical output 1 GHz



Optical output 5 GHz

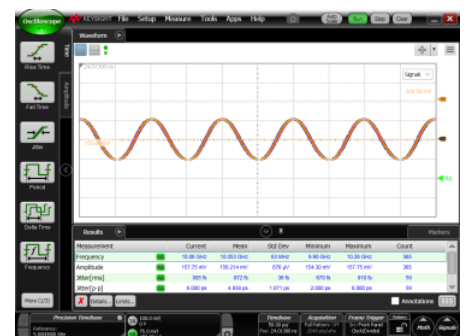

Optical output 10 GHz

Interfaces, Dimensions and Compliance

ID	Interfaces	
3.1	Optical input and output ports	Polarization maintaining fiber / FC/APC optical connectors, narrow key, slow axis // to the key
3.2	RF input	Single SMA female RF connector - 50 Ω
3.3	Control	Smart Interface (front panel tactile interface), GUI (Ethernet)
3.4	Power supply	100 V-120 V / 220 V - 240 V automatic switch 50 Hz - 60 Hz (Rear panel)
3.5	Dimensions / Weight	Rack 19" x 3U, Depth=495mm / 5 kg
3.6	EMC and optical norms	EN61326-1 Ed. 2006 / NF EN 60825-1 & EN 60825-2 Ed.2014

About us

iXblue Photonics produces specialty optical fibers and Bragg gratings based fiber optics components and provides optical modulation solutions based on the company lithium niobate (LiNbO₃) modulators and RF electronic modules.

iXblue Photonics serves a wide range of industries: sensing and instruments, defense, telecommunications, space and fiber lasers as well as research laboratories all over the world.