

MODULATOR

MX-LN series

1550 nm band intensity Modulators

The MX-LN series are lithium niobate (LiNbO₃) intensity modulators designed for optical communications at data rates up to 56 Gb/s.

The X-cut design of these Mach-Zehnder modulators confer them an unmatched stability in a wide range of operational conditions, as well as a zero chirp performance. Exail proprietary waveguide design offers a low insertion loss combined with a high contrast. The MX-LN series are ideally suited for few kb/s up to 56 Gb/s optical transmission with NRZ, RZ, DPSK, Duo Binary modulation formats and are key device for a large variety of high bandwidth applications.



Features

- High bandwidth
- X-cut for high stability
- Low drive voltage
- Low insertion loss

Applications

- Digital communications
- General purpose intensity modulation
- Test and measurement

Options

- High extinction ratio versions
- 2000 nm, 1300 nm, 1060 nm, 850 nm
- Low insertion loss
- Space grade version

Related Equipments

- RF amplifiers
- MBC-DG Automatic Bias Controllers
- Modbox-CBand-VNA

MX-LN-0.1 Performance Highlights*

Parameter	Min	Typ	Max	Unit
Operating wavelength	1530	1550	1580	nm
Electro-optical bandwidth	100	400	-	GHz

MX-LN-05 Performance Highlights*

Parameter	Min	Typ	Max	Unit
Operating wavelength	1530	1550	1580	nm
Electro-optical bandwidth	3	4	-	GHz

MX-LN-10 Performance Highlights*

Parameter	Min	Typ	Max	Unit
Operating wavelength	1530	1550	1625	nm
Electro-optical bandwidth	10	12	-	GHz

MX-LN-20 Performance Highlights*

Parameter	Min	Typ	Max	Unit
Operating wavelength	1530	1550	1625	nm
Electro-optical bandwidth	20	25	-	GHz

MX-LN-40 Performance Highlights*

Parameter	Min	Typ	Max	Unit
Operating wavelength	1530	1550	1625	nm
Electro-optical bandwidth	28	30	-	GHz

*Specifications given at 25 °C, 1550 nm

MX-LN-0.1

100 MHz Intensity Modulator

Electrical Characteristics

Parameter	Symbol	Condition	Min	Typ	Max	Unit
Electro-optical bandwidth ⁽¹⁾	S_{21}	RF electrodes	100	400	-	MHz
Ripple S_{21} ⁽¹⁾	ΔS_{21}	RF electrodes	-	0.5	1	dB
V_{π} RF @50 kHz	$V_{\pi_{RF\ 50\ kHz}}$	RF electrodes, @ 1550 nm	-	3.5	4	V
V_{π} RF @200 Mb/s PRBS	$V_{\pi_{RF\ 200\ Mb/s}}$	RF electrodes, @ 1550 nm	-	1.5	-	V
V_{π} DC electrodes	$V_{\pi_{DC}}$	DC electrodes	-	6.5	7	V
RF input impedance	Z_{in-RF}	From DC to 400 MHz	High impedance			-
DC input impedance	Z_{in-DC}	-	1	-	-	M Ω

⁽¹⁾ DC coupled amplitude modulator. RF modulation applies from DC to 400 MHz

Optical Characteristics

Parameter	Symbol	Condition	Min	Typ	Max	Unit
Crystal	-	-	Lithium Niobate X-Cut Y-Prop			
Operating wavelength	λ	-	1530	1550	1580	nm
Insertion loss	IL	Without optical connectors ⁽¹⁾	-	3.5	4.5	dB
DC Extinction ratio	ER	Measured with narrow source linewidth < 200 MHz	20	30	-	dB
Optical return loss	ORL	-	-40	-45	-	dB
Chirp	α	-	-0.1	-	0.1	-

All specifications given at 25 °C, 1550 nm, unless differently specified.

⁽¹⁾ Consider an extra-loss up to 0.25 dB for each FC/APC optical connector

Absolute Maximum Ratings

Stresses in excess of the absolute maximum ratings can cause permanent damage to the device. These are absolute stress ratings only. Functional operation of the device is not implied at these or any other conditions in excess of those given in the operational sections of the data sheet. Exposure to absolute maximum ratings for extended periods can adversely affect device reliability.

Parameter	Symbol	Min	Max	Unit
RF input power	EP_{in}	-	N/A	-
Bias Voltage	V_{bias}	-20	+20	V
Optical input power	OP_{in}	-	20	dBm
Operating temperature	OT	0	+70	°C
Storage temperature	ST	-40	+85	°C

MX-LN-05

5 GHz Intensity Modulator

Electrical Characteristics

Parameter	Symbol	Condition	Min	Typ	Max	Unit
Electro-optical bandwidth	S_{21}	RF electrodes	3	4	-	GHz
Ripple S_{21}	ΔS_{21}	RF electrodes	-	0.5	1	dB
Electrical return loss, 0-5 GHz	S_{11}	RF electrodes	-	-13	-10	dB
V_{π} RF @50 kHz	$V_{\pi_{RF\ 50\ kHz}}$	RF electrodes, @ 1550 nm	-	3.5	4	V
V_{π} DC electrodes	$V_{\pi_{DC}}$	DC electrodes	-	6.5	7	V
RF input impedance	Z_{in-RF}	-	-	50	-	Ω
DC input impedance	Z_{in-DC}	-	1	-	-	M Ω

50 Ω RF input

Optical Characteristics

Parameter	Symbol	Condition	Min	Typ	Max	Unit
Crystal	-	-	Lithium Niobate X-Cut Y-Prop			
Operating wavelength	λ	-	1530	1550	1580	nm
Insertion loss	IL	Without optical connectors ⁽¹⁾	-	3.5	4.5	dB
DC Extinction ratio	ER	Measured with narrow source linewidth < 200 MHz	20	25	-	dB
Optical return loss	ORL	-	-40	-45	-	dB
Chirp	α	-	-0.1	-	0.1	-

All specifications given at 25 °C, 1550 nm, unless differently specified.

⁽¹⁾ Consider an extra-loss up to 0.25 dB for each FC/APC optical connector

Absolute Maximum Ratings

Stresses in excess of the absolute maximum ratings can cause permanent damage to the device. These are absolute stress ratings only. Functional operation of the device is not implied at these or any other conditions in excess of those given in the operational sections of the data sheet. Exposure to absolute maximum ratings for extended periods can adversely affect device reliability.

Parameter	Symbol	Min	Max	Unit
RF input power	EP_{in}	-	28	dBm
Bias Voltage	V_{bias}	-20	+20	V
Optical input power	OP_{in}	-	20	dBm
Operating temperature	OT	0	+70	°C
Storage temperature	ST	-40	+85	°C

MX-LN-10

10 GHz Intensity Modulator

Electrical Characteristics

Parameter	Symbol	Condition	Min	Typ	Max	Unit
Electro-optical bandwidth	S_{21}	RF electrodes	10	12	-	GHz
Ripple S_{21}	ΔS_{21}	RF electrodes	-	0.5	1	dB
Electrical return loss	S_{11}	RF electrodes	-	-12	-10	dB
V_{π} RF @50 kHz	$V_{\pi_{RF\ 50\ kHz}}$	RF electrodes, @ 1550 nm	-	5.5	6.5	V
V_{π} RF @10 Gb/s PRBS	$V_{\pi_{RF\ 10\ Gb/s}}$	RF electrodes, @ 1550 nm	-	6.5	7	V
V_{π} DC electrodes	$V_{\pi_{DC}}$	DC electrodes	-	6.5	7	V
RF input impedance	Z_{in-RF}	-	-	50	-	Ω
DC input impedance	Z_{in-DC}	-	-	1	-	M Ω

50 Ω RF input

Optical Characteristics

Parameter	Symbol	Condition	Min	Typ	Max	Unit
Crystal	-	-	Lithium Niobate X-Cut Y-Prop			
Operating wavelength	λ	-	1530	1550	1625	nm
Insertion loss	IL	Without optical connectors ⁽¹⁾	-	3.5	-	dB
Insertion loss (with low IL option)	LIL	Without optical connector ⁽¹⁾	-	2.7	3	dB
DC Extinction ratio	ER	Measured with narrow source linewidth < 200 MHz	20	22	-	dB
Optical return loss	ORL	-	-40	-45	-	dB
Chirp	α	-	-0.1	0	0.1	-

All specifications given at 25 °C, 1550 nm, unless differently specified.

⁽¹⁾ Consider an extra-loss up to 0.25 dB for each FC/APC optical connector

Absolute Maximum Ratings

Stresses in excess of the absolute maximum ratings can cause permanent damage to the device. These are absolute stress ratings only. Functional operation of the device is not implied at these or any other conditions in excess of those given in the operational sections of the data sheet. Exposure to absolute maximum ratings for extended periods can adversely affect device reliability.

Parameter	Symbol	Min	Max	Unit
RF input power	EP_{in}	-	28	
Bias Voltage	V_{bias}	-20	+20	V
Optical input power	OP_{in}	-	20	dBm
Operating temperature	OT	0	+70	°C

MX-LN-20

20 GHz Intensity Modulator

Electrical Characteristics

Parameter	Symbol	Condition	Min	Typ	Max	Unit
Electro-optical bandwidth	S_{21}	RF electrodes, from 2 GHz	20	25	-	GHz
Ripple S_{21}	ΔS_{21}	RF electrodes, $f < 20$ GHz	-	0.5	1	dB
Electrical return loss	S_{11}	RF electrodes	-	-12	-10	dB
V_{π} RF @50 kHz	$V_{\pi_{RF\ 50\ kHz}}$	RF electrodes, @ 1550 nm	-	5	5.5	V
V_{π} RF @20 Gb/s PRBS	$V_{\pi_{RF\ 20\ Gb/s}}$	RF electrodes, @ 1550 nm	-	5.5	6	V
V_{π} DC electrodes	$V_{\pi_{DC}}$	DC electrodes	-	6.5	7	V
RF input impedance	Z_{in-RF}	-	-	50	-	Ω
DC input impedance	Z_{in-DC}	-	-	1	-	M Ω

50 Ω RF input

Optical Characteristics

Parameter	Symbol	Condition	Min	Typ	Max	Unit
Crystal	-	-	Lithium Niobate X-Cut Y-Prop			
Operating wavelength	λ	-	1530	1550	1625	nm
Insertion loss	IL	Without connector ⁽¹⁾	-	3.5	4.5	dB
DC Extinction ratio	ER	Measured with narrow source linewidth < 200 MHz	20	22	-	dB
Optical return loss	ORL	-	-40	-45	-	dB
Chirp	α	-	-0.1	0	0.1	-

All specifications given at 25 °C, 1550 nm, unless differently specified.

⁽¹⁾ Consider an extra-loss up to 0.25 dB for each FC/APC optical connector

Absolute Maximum Ratings

Stresses in excess of the absolute maximum ratings can cause permanent damage to the device. These are absolute stress ratings only. Functional operation of the device is not implied at these or any other conditions in excess of those given in the operational sections of the data sheet. Exposure to absolute maximum ratings for extended periods can adversely affect device reliability.

Parameter	Symbol	Min	Max	Unit
RF input power	EP_{in}	-	28	dBm
Bias Voltage	V_{bias}	-20	+20	V
Optical input power	OP_{in}	-	20	dBm
Operating temperature	OT	0	+70	°C
Storage temperature	ST	-40	+85	°C

MX-LN-40

40 GHz Intensity Modulator

Electrical Characteristics

Parameter	Symbol	Condition	Min	Typ	Max	Unit
Electro-optical bandwidth	S_{21}	RF electrodes, from 2 GHz	28	30	-	GHz
Ripple S_{21}	ΔS_{21}	RF electrodes, $f < 30$ GHz	-	0.5	1	dB
Electrical return loss	S_{11}	RF electrodes	-	-12	-10	dB
V_{π} RF @50 kHz	$V_{\pi_{RF\ 50\ kHz}}$	RF electrodes, @ 1550 nm	-	5	6	V
V_{π} DC electrodes	$V_{\pi_{DC}}$	DC electrodes, @ 1550 nm	-	6.5	7	V
RF input impedance	Z_{in-RF}	-	-	50	-	Ω
DC input impedance	Z_{in-DC}	-	1	-	-	M Ω

50 Ω RF input

Optical Characteristics

Parameter	Symbol	Condition	Min	Typ	Max	Unit
Crystal	-	-	Lithium Niobate X-Cut Y-Prop			
Operating wavelength	λ	-	1530	1550	1625	nm
Insertion loss	IL	Without optical connectors ^{††}	-	3.5	4.5	dB
DC Extinction ratio	ER	Measured with narrow source linewidth < 200 MHz	20	22	-	dB
Optical return loss	ORL	-	-40	-45	-	dB
Chirp	α	-	-0.1	0	0.1	-

All specifications given at 25 °C, 1550 nm, unless differently specified.

^{††}Consider an extra-loss up to 0.25 dB for each FC/APC optical connector

Absolute Maximum Ratings

Stresses in excess of the absolute maximum ratings can cause permanent damage to the device. These are absolute stress ratings only. Functional operation of the device is not implied at these or any other conditions in excess of those given in the operational sections of the data sheet. Exposure to absolute maximum ratings for extended periods can adversely affect device reliability.

Parameter	Symbol	Min	Max	Unit
RF input power	EP_{in}	-	28	dBm
Bias Voltage	V_{bias}	-20	+20	V
Optical input power	OP_{in}	-	20	dBm
Operating temperature	OT	0	+70	°C
Storage temperature	ST	-40	+85	°C

MX-LN-0.1 & 05

MX-LN-0.1 Typical S_{21} Curve

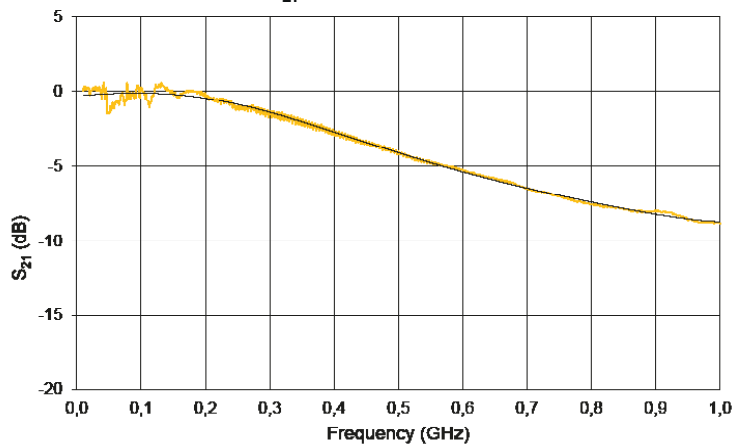

MX-LN-0.1 Typical S_{11} Curve

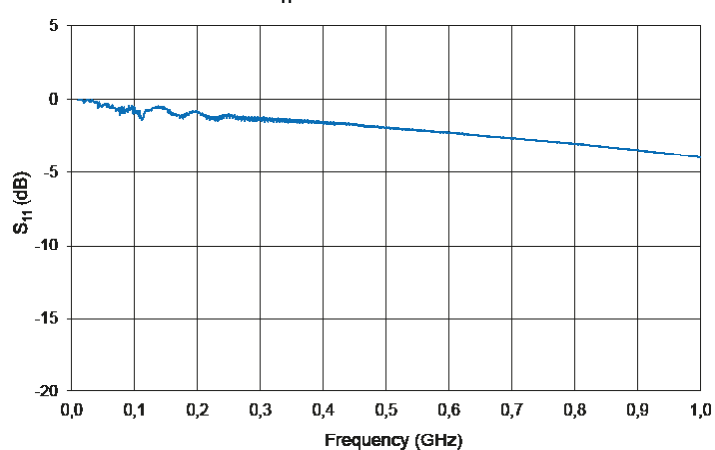

MX-LN-05 Typical S_{21} Curve

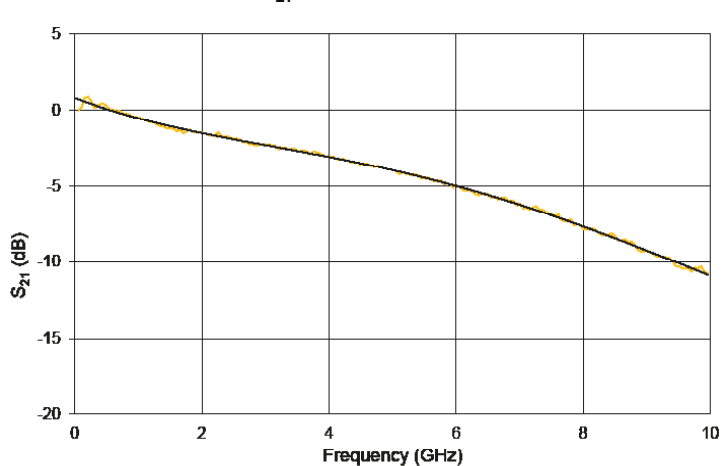

MX-LN-05 Typical S_{11} Curve

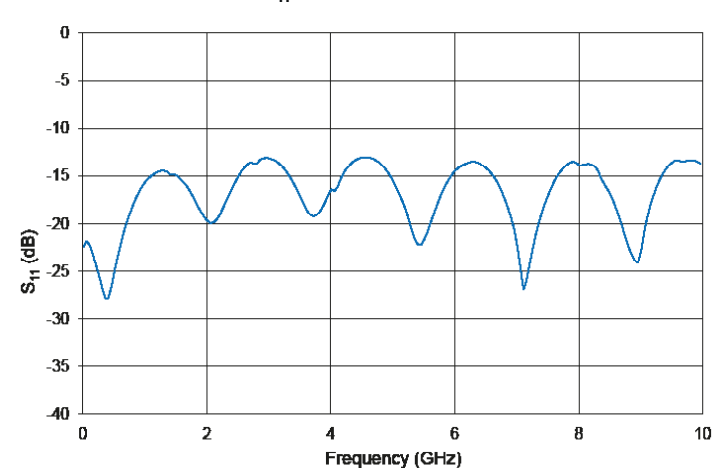

MX-LN-10, 20 & 40

MX-LN-10 Typical S_{21} Curve

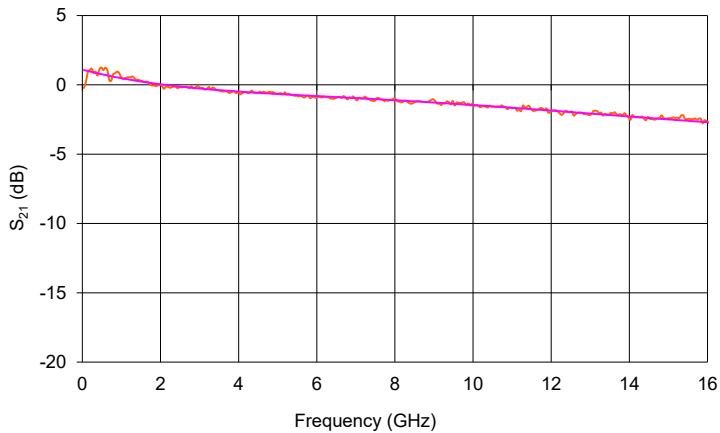

MX-LN-10 Typical S_{11} Curve

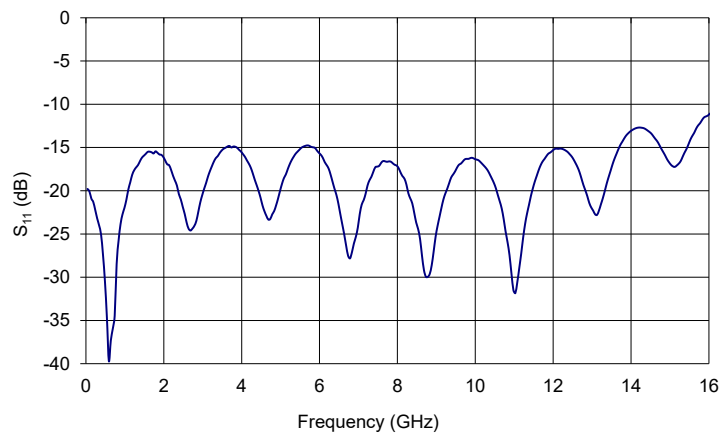

MX-LN-20 Typical S_{21} Curve

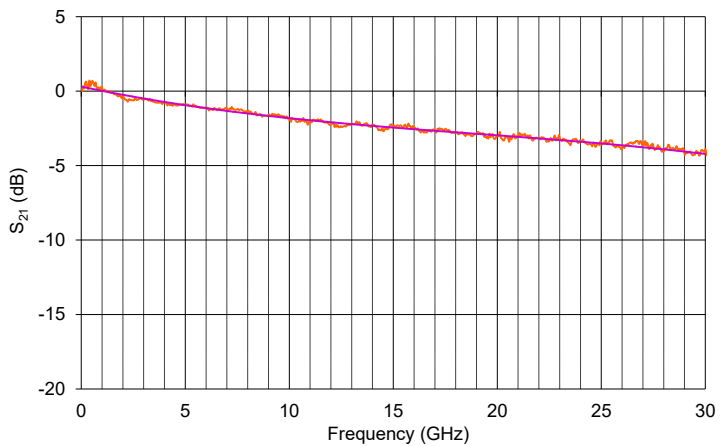

MX-LN-20 Typical S_{11} Curve

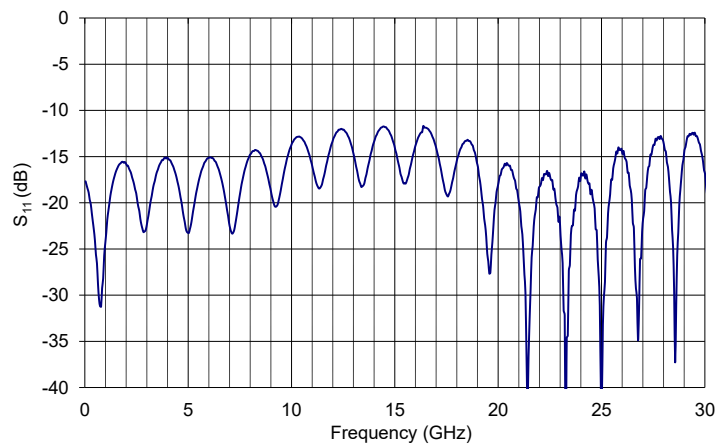

MX-LN-40 Typical S_{21} Curve

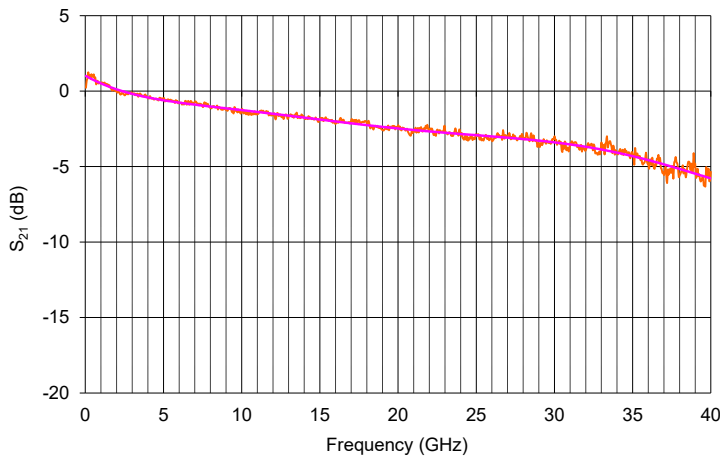

MX-LN-40 Typical S_{11} Curve

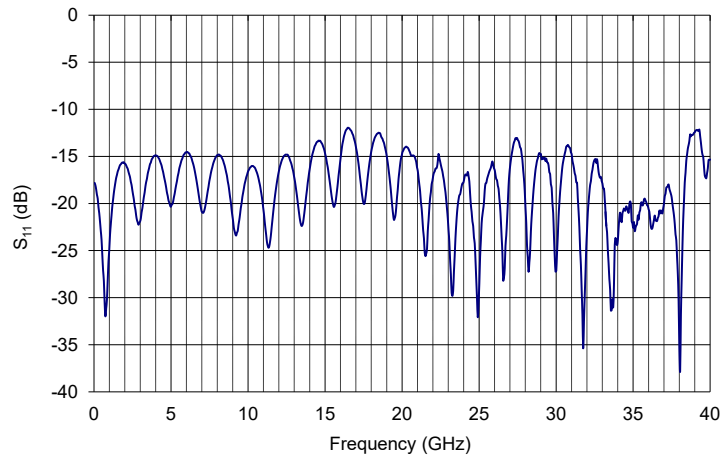

MODULATOR | MX-LN SERIES | 9/9

Mechanical Diagram and Pinout

All measurements in mm

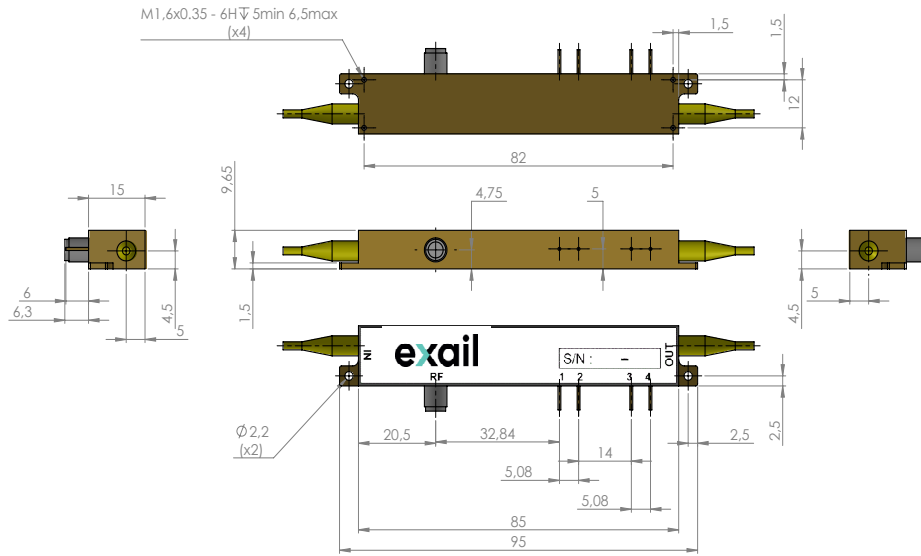

Port	Function	Note
IN	Optical input port	Polarization maintaining fiber Corning PM 15-U25D Length: 1.5 meter, buffer diameter: 900 µm
OUT	Optical output port	Polarization maintaining fiber Corning PM 15-U25D Length: 1.5 meter, buffer diameter: 900 µm
RF	RF input port	MX-LN-0.1, 05, 10: Female K (SMA compatible) MX-LN-20: Female K or 2.4 mm (optional) MX-LN-40: 2.4 mm, female, compatible to mate with V / 1.85 mm connectors (K option)
1	Ground	Pin feed through diameter 1.0 mm
2	DC	Pin feed through diameter 1.0 mm
3, 4	Photodiode cathode, anode	Pin feed through diameter 1.0 mm

Ordering information

MX-LN-□-□-□-□-□-□-□

- Bandwidth: **0.1** (400 MHz), **05** (5 GHz), **10** (10 GHz), **20** (20 GHz), **40** (40 GHz)
- Internal photodiode: "**PD**": integrated, "**00**": not integrated (by default)
- Input fiber: **P** Polarization maintaining
- Output fiber: **P** Polarization maintaining, **S** Standard single mode fiber
- Input connector: **00** (bare fiber), **FA** (FC/APC)
- Output connector: **00** (bare fiber), **FA** (FC/APC)
- LIL**: Low Insertion Loss option

About us

Exail reserves the right to change, at any time and without notice, the specifications, design, function or form of its products described herein.

contact.photonics@exail.com | www.exail.com

Europe +33 1 30 08 87 43 | Americas +1 508 745 3487 | APAC +65 6747 4912

