

Phins Subsea

FOG-based high-performance subsea inertial navigation system for deep water

Phins Subsea is a subsea inertial navigation system providing position, true heading, attitude, speed, depth and heave. Its high-accuracy inertial measurement unit is coupled with an embedded digital signal processor that runs an advanced Kalman filter. Phins Subsea can be pre-assembled and pre-calibrated with a doppler velocity log sensor, making the system easy to install and ready to use for more precise navigation.



FEATURES

- All-in-one high-accuracy 3D positioning with heading, roll and pitch
- FOG, unique strap-down technology
- Multiple aiding sensors available: DVL, USBL, LBL, RAMSES, GPS, pressure sensor
- Multi DVL tightly coupled solutions
- Ethernet, web server (GUI)

BENEFITS

- High grade INS performance
- High reliability and maintenance free
- Rugged design for water depths up to 6,000 m
- Ultimate sub-metric performance using sparse array transponders and on-the-fly calibration
- Ease of use and quick installation

APPLICATIONS

- Various subsea vehicle such as AUV, ROV, towfish & ROTV
- Subsea metrology
- Subsea construction support

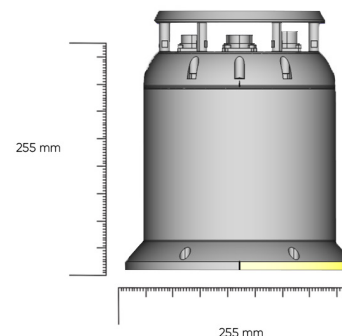
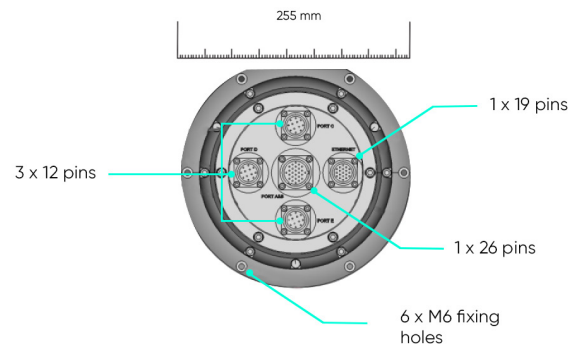

TECHNICAL SPECIFICATIONS

Performance/Characteristics

Position accuracy ⁽¹⁾	
With GNSS/USBL/LBL	Three times better than GNSS/USBL/LBL
DVL-Aided straight line performance	0.05 %TD (CEP 50)
DVL-aided optimal performances in typical conditions	0.01 %TD (CEP 50)
No aiding for 60s / 120s	0.06 m / 0.3 m (CEP50)
Heading accuracy ⁽²⁾⁽³⁾⁽⁴⁾	
With GNSS (or USBL/LBL) & DVL	0.010 deg secant latitude RMS
With GNSS or DVL or USBL/LBL	0.025 deg secant latitude RMS
Roll and pitch dynamic accuracy (no aiding)	0.01 deg RMS

Operating range/Environment

Operating/Storage temperature	-20 to 55 °C / -40 to 80 °C
Rotation rate dynamic range	Up to 750 °/sec
Acceleration dynamic range	+/-30g
Heading/Roll/Pitch ranges	0 to +360 deg / ±180 deg / ±90 deg
MTBF	150,000 hours (System observed) 500,000 hours (FOG + accelerometers)
Robust to harsh environment, shock and vibration proof	Robust to harsh environment, shock and vibration proof
Depth rating	6,000 m

Physical characteristics

Material	Titanium
Weight in air/water	23 kg / 13 kg
Mounting (Ø in mm)	6 x Ø M6
Dimensions (Ø x H)	Ø 255 x 288 mm
Connectors	3 x 12 pins, 1 x 19 pins, 1 x 26 pins SEACON

Interfaces

Sensors	GNSS/USBL/LBL/DVL/EMLOG/DEPTH/CTD/SVP
Serial	5 ports : RS422 or RS232
Ethernet	10/100 Mbits, UDP/TCP (client/server)/web server (GUI)
Pulse	3 inputs / 2 outputs
Input/Output	Configurable 7i / 5o Industry standards: NMEA, ASCII, Exail STD BIN etc... more than 130 output protocols
Baud rate	Up to 460 kbaud
Data output rate	0.1 Hz to 200 Hz
Power supply/consumption ⁽⁵⁾	24 VDC (20 - 32 V) / < 20 W

(1) CEP: 50% circular error probability. DVL aiding position accuracy is dependent on DVL performances.

(2) Typical performances, dependent on external sensor characteristics

(3) RMS values.

(4) Secant Latitude= 1 / Cosine Latitude

(5) Phins subsea own power consumption, not taking into account external sensors, typical value @24V and ambient temperature.